

BABY WINCH

Operation Manual

Catalogue

Every winching situation has the potential for personal injury. In order to minimize that risk, it is important to read this manual carefully. Please familiarize yourself with the operation of your winch before using it and be constantly safety oriented. In this manual we provide important safety information and instructions on how to install your winch.

SAVE THIS MANUAL and other product literature found in this kit for future reference and review frequently for continuing safe operation. Instruct all users of this product to review this manual before operating this product.

In this kit you will find the following pieces of literature: Winch direction, specifications and performance Data.















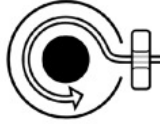



SAFETY

Symbol Index	2
General Safety Precautions	3-8

INSTRUCTIONS

Know Your Winch.....	9-12
Operating Instructions.....	13-17
Final Analysis and Maintenance.....	18

SYMBOL INDEX

SYMBOL	EXPLANATION	SYMBOL	EXPLANATION
	Always Read All Product Literature		Instructions For Use
	Always Wear Hearing and Eye Protection		Never Apply Load to Hook Tip Or Latch
	Never Use As a Hoist		Always Wind Winch Rope From Top Of Drum
	Always Properly Seat Load in Throat of Hook		Fairlead Pinch Point
	Never Wind Winch Rope On Bottom Of Drum		Fire And Burn Hazard
	Finger/Fairlead Crushing Hazard		Never Hook Back On Rope
	Hand Piercing/Cutting Hazard		Always Use Supplied Hook Strap
	Explosion/Bursting Hazard		Always Wear Heavy Gloves
	Lock(Engage)		Never Move People
	Unlock(Disengage)		

GENERAL SAFETY PRECAUTIONS

Warnings and Cautions



As you read these instructions, you will see WARNINGS, CAUTIONS, NOTICES and NOTES. Each message has a specific purpose. WARNINGS are safety messages that indicate a potentially hazardous situation, which, if not avoided, could result in serious injury or death. CAUTIONS are safety messages that indicate a potentially hazardous situation, which, if not avoided, could result in minor or moderate injury. A CAUTION may also be used to alert against unsafe practice. CAUTIONS and WARNINGS identify the hazard, indicate how to avoid the hazard, and advise of the probable consequence of not avoiding the hazard. NOTICES are messages to avoid property damage. NOTES are additional information to help you complete a procedure.

PLEASE WORK SAFELY!

WARNING



MOVING PARTS ENTANGLEMENT HAZARD

Failure to observe these instructions could lead to serious injury or death.

- **Always** ensure hook latch is closed and not supporting load.
- **Never** apply load to hook tip or latch. Apply load only to the center of hook.
- **Never** use a hook whose throat opening has increased, or whose tip is bent or twisted.
- **Always** use a hook with a latch.
- **Always** ensure the operator and bystanders are aware of the stability of the load.
- **Never** wrap winch rope back onto itself. Use a choker chain or tree trunk protector on the anchor.

WARNING



MOVING PARTS ENTANGLEMENT HAZARD

Failure to observe these instructions could lead to serious injury or death.

General Safety:

- **Always** Know your Winch. Take time to fully read Operations manual in order to understand your winch and its operations.
- **Always** read and understand your drill/driver operator's manual and instructions.
- **Never** exceed winch or winch rope rated capacity.
- **Always** wear heavy gloves when handling winch rope.
- **Always** remove jewelry and wear eye and ear protection.
- **Never** use winch or winch rope for towing. Shock loads can damage, overload and brake rope.
- **Never** use a winch to secure a load.
- **Never** operate this winch when under the influence of drugs, alcohol or medication.
- **Never** operate this winch if you are under 16 years of age.
- **Never** operate winch without reading or understanding the operator's manual.

Installation Safety:

- **Always** keep hands clear of winch rope, hook loop, hook and fairlead opening during installation, operation, and when spooling in or out.
- **Always** position fairlead with warning readily visible on top.
- **Always** respool under load before each use. Tightly wound rope reduces chances of "binding", which can damage the rope.

WARNING



MOVING PARTS ENTANGLEMENT HAZARD

Failure to observe these instructions could lead to serious injury or death.

Winching Safety:

- **Always** inspect winch rope, hook, and slings before operating winch. Frayed, kinked or damaged winch rope must be replaced immediately. Damaged components must be replaced before operation. Protect parts from damage.
- **Never** use product if winch rope is damaged.
- **Always** remove any element or obstacle that may interfere with safe operation of the winch.
- **Always** be certain the anchor you select will withstand the load and the strap or chain will not slip.
- **Always** use supplied hook strap whenever spooling winch rope in or out, during installation and during operation.
- **Never** use “bungie” straps that develop tremendous and potentially dangerous amounts of force when stretched.
- **Always** require operators and bystanders to be aware of rope and load.
- **Always** be aware of stability of load during pulling. Keep others away. Alert all bystanders of an unstable condition.
- **Always** unspool as much winch rope as possible when rigging. Pick a distant anchor point.
- **Always** take time to use appropriate rigging techniques for a winch pull.
- **Never** touch winch rope or hook while someone else is at the control switch or during winching operation.
- **Never** engage or disengage clutch if winch is under load, winch rope is in tension or drum is moving.
- **Never** touch winch rope or hook while under tension or under load.
- **Always** stand clear of winch rope and load and keep others away while winching.
- **Never** use the winch’s rope to tow a vehicle or object. Impact loading during towing can exceed rope strength.
- **Never** wrap winch rope back onto itself. Use a choker chain or tree trunk protector on the anchor.
- **Never** leave the winch drill/driver power cord plugged in when installing, rigging, servicing or when the winch is not being used.

⚠ WARNING

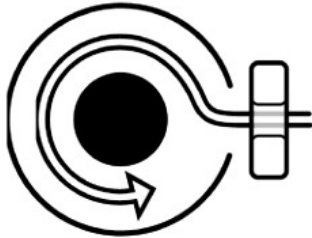

FALLING OR CRUSHING HAZARD

Failure to observe these instructions could lead to serious injury or death.

- **Always** stand clear of winch rope and load and keep others away while winching.
- **Never** operate winch with less than 5 wraps of rope around the drum. Rope could come loose from the drum, as the rope attachment to the drum is not designed to hold a load.
- **Always** keep winch and winching load in sight during winching operation.
- **Never** use as a hoist.
- **Never** use winch to secure a load.
- **Always** be certain anchor will withstand load, use appropriate rigging and take time to rig correctly.
- **Never** use winch to lift or move persons.
- **Never** shock load rope. Shock loading can damage, overload and brake rope.
- **Always** wind the winch rope on top of drum.
- **Never** wind rope from bottom of drum.
- **Always** spool the winch rope onto the drum in the direction specified by the drum rotation labels on the winch and in the documentation.
- **Always** remove any element or obstacle that may interfere with safe operation of the winch.
- **Always** tightly wind rope onto drum after each use. During spooling in or out, rope direction can unexpectedly switch if rope is bound in layers on drum. Tightly wound rope reduces chance of binding.

! CAUTION



CUT AND BURN HAZARD

Failure to observe these instructions could lead to minor or moderate injury.

- **Always** wear heavy gloves when handling winch and winch rope.
- **Never** let winch rope slip through your hands.
- **Never** touch winch rope during operation.

! CAUTION

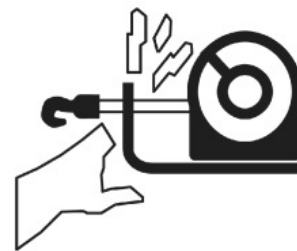

MOVING PARTS ENTANGLEMENT HAZARD

Failure to observe these instructions could lead to minor or moderate injury.

To avoid injury to hands or fingers:

- **Always** keep hands clear of winch rope, hook loop, hook and fairlead opening during installation, operation, and when spooling in or out.

- **Always** keep hands and clothing clear of the rope, hook and fairlead opening during operation and when spooling.
- **Always** remove any element or obstacle that may interfere with safe operation of the winch.
- **Never** let drill/driver loose from grip. Drill/driver kickback can occur very suddenly and with great force if left loose.
- **Always** make sure the drill/driver is secured to the winch driver shaft tightly. Drill/driver can come loose and cause injury.



NOTICE

AVOID WINCH AND EQUIPMENT DAMAGE

- **Always** avoid continuous side pulls which can pile up winch rope at one end of the drum. This can damage winch rope or winch.
- **Always** ensure the clutch is fully engaged or disengaged.
- **Always** avoid on/off cycles (jogging or plugging).
- **Always** store the winch in a protected, clean, dry area.
- **Always** select an anchor point as far away as possible. This will provide the winch with its greatest winching power.
- **Always** avoid over heating the drill/driver motor. For extended winching, stop at reasonable intervals to allow the drill motor to cool down. See your drill manufacturer's operating instructions for recommended running times.

KNOW YOUR WINCH

Before you begin, you should familiarize yourself with your winch and each of its components:

Model: ATQ-500H
Capacity: 500 lbs

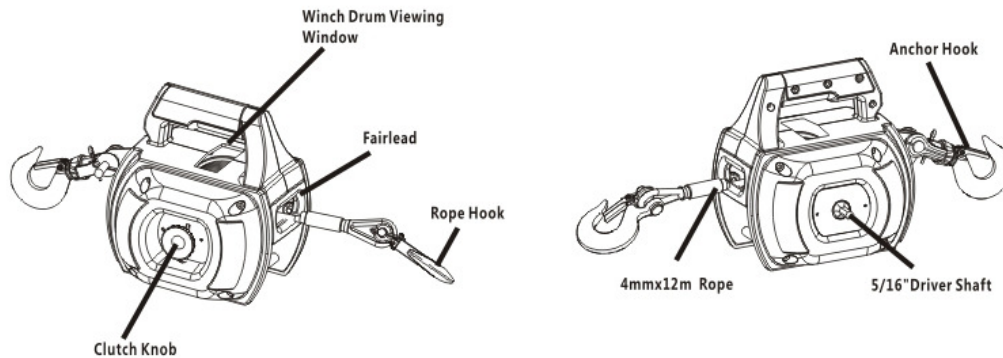

5/16" Drill/Driver Shaft: The winch is powered by a standard drill/driver (non-impact). The 5/16" drill/driver shaft provides torque to the gear mechanism, which turns the winch drum and winds and unwinds the winch rope.

Winch Drum

Viewing Window:

The winch drum viewing window is a cut out on top of the winch to view the winch rope winding on the winch drum.

Rope:

The winch rope is wrapped around the winch drum and fed through the fairlead. The winch rope is looped at the end to accept the hook's clevis pin. Stand winch rope is 4mmx12m.

Gear Train:

The gear train converts the drill's torque into a large Winching force. The gear train design makes it possible for the winch to be lighter and more compact.

Clutch Knob:

The clutch knob allows the operator to manually disengage (unlock) the drum from the gear train, enabling the drum to rotate freely (known as "freespooling"). Engaging the clutch "locks" the winch drum back onto the gear train.

Rope Hook:

The rope hook is attached to the end of the winch rope. The rope hook is rated according to the winch's capacity. Hooks are usually used in combination with straps or chains.

Anchor Hook:

The anchor hook is fastened to the anchor point. A strap will be connected to the hook and then secured to a solid connection (anchor).

Fairlead:

The fairlead acts to guide the winch rope onto the drum.

WINCH MECHANICS

Before using your winch it is essential to understand how it works and the functions of the key components.

⚠️ WARNING Always Know your winch. Take time to fully read the Operations Manual in order to understand your winch and its operations.

⚠️ WARNING Always read and understand your drill/driver operator's manual and instructions.

How the Winch Reacts to Load

The winch is rated by winching capacity. The maximum winching torque occurs when there is only one layer of winch rope on the drum. As the layers of winch rope on the drum increase, the pulling power decreases. This is basics of mechanical advantage.

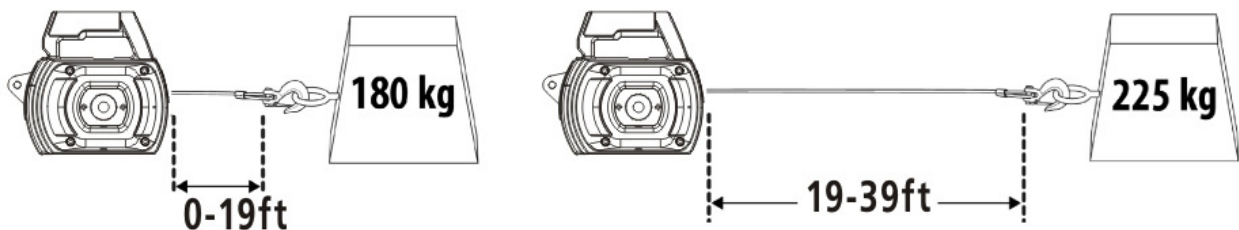

Load Limiter

⚠️ WARNING Never engage or disengage clutch if winch is under load, winch rope is in tension or drum is moving.

⚠️ WARNING Never touch winch rope or hook while under tension or under load.

Exceeding the winch capacity will cause the mechanical load limiter to ratchet, which interrupts the power from the drill/driver. With increasing load the ratcheting frequency increases resulting in a reduction in the line speed. When this occurs, stop winching, reverse direction of drill/driver and power-out to reduce the load. Never use freespool clutch when the winch rope is under load.

Do not attempt to apply the same load if the load limiter continues to ratchet, as this can damage the unit.

If the load limiter continues to ratchet, perform the following actions:

- (1) Reduce the weight of the load.
- (2) Increase the distance of the anchor point.

The maximum pulling capacity occurs from the first layer of winch rope on the drum. By increasing the distance between the winch and the anchor point, it decreases the layers of winch rope on the drum, therefore increasing the pulling power.

Run Time/Duty Cycle

Follow the your drill/driver manufacturer's recommended run times and cooling times.

KEY COMPONENT FUNCTIONS

Rotation control switch:

The winch is controlled by a standard drill/driver.

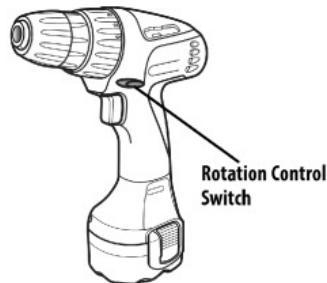

The rotation control switch is commonly located near the speed trigger. **NOTE: See your specific drill/driver instructions for your specific rotation control switch placement and operation.**

The rotation control switch on the drill provides control of the power-in (forward/clockwise) and power-out (reverse/counterclockwise) operation.

Speed Trigger:

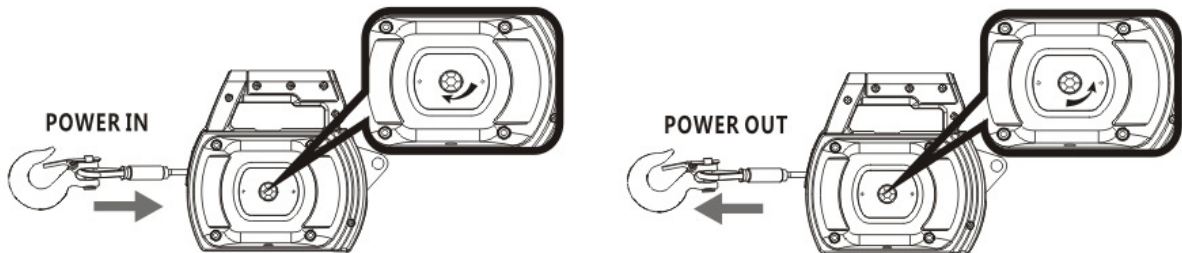

The drill/driver's speed trigger controls the power and speed of the power-in and power-out operation.

To turn the winch ON, depress the drill trigger.



To turn the winch OFF, release the trigger.

The speed is controlled by the amount of trigger depression.

NOTICE Some drill/driver models offer a trigger that can be locked in the OFF position. We suggest using this feature to help reduce the possibility of accidental powering on when not in use. See your specific drill/driver's instructions for details.

Clutch Operation:

⚠️ WARNING Never engage or disengage clutch if winch is under load, winch rope is in tension or drum is moving.

The clutch allows the operator to disengage the drum from the gear train, enabling the drum to rotate freely, known as “freespooling”. Engaging the clutch “locks” the winch drum back onto the gear train.

The clutch lever, located on the winch housing opposite the drill/driver shaft, controls the clutch position. Pull out the knob and turn it clockwise to freewheel, the clutch is disengaged.

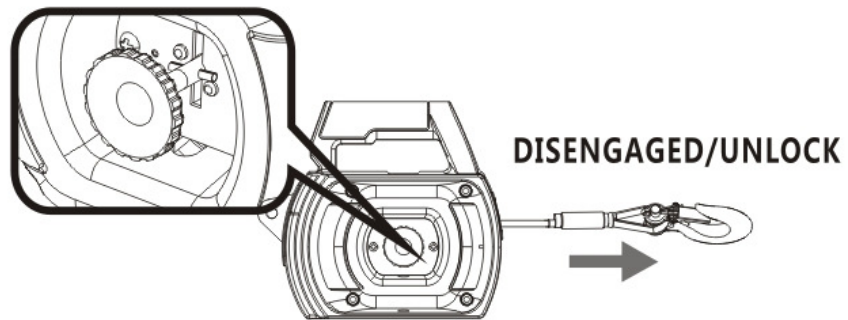

Pull out the knob and turn it counterclockwise to have the clutch fully engaged again.

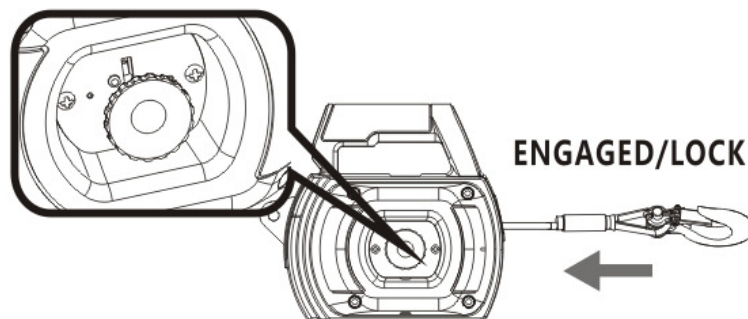

The clutch will not disengage the gear train if there is tension on the winch rope greater than 15lbs. To prevent damage, always fully lock(engage) or fully unlock(disengage) the clutch lever.

⚠️ WARNING Always ensure the clutch is fully engaged or disengaged.

OPERATING INSTRUCTIONS

OPERATING INSTRUCTIONS

Knowing the proper winching techniques can help keep you and others around you safe.

In this guide, you are shown the basic fundamentals for effective winching. However, it is up to you to analyze the situation and make the decisions necessary for the proper use of your winch.

Apply your knowledge of your winch and the basic fundamentals you have practiced to adjust your techniques to each unique situation.

Getting Started

(1) Things you will need to operate your winch:

- All operating instructions
- Winch
- Winch Rope
- Rope hook
- Anchor hook

Items sold separately:

- Standard Drill/Driver (minimum drive torque 3ft.lbs.-4N-m)
- Gloves
- Rigging Accessories (straps, shackles, etc.)

(2) Upon removing winch from packaging, it is very important to thoroughly inspect all parts of the system prior to winching. If any parts are missing or damaged, it must be immediately replaced.

Rigging Procedures

The following steps describe rigging for single line winching. Double and multiple line rigging is not recommended with this product.

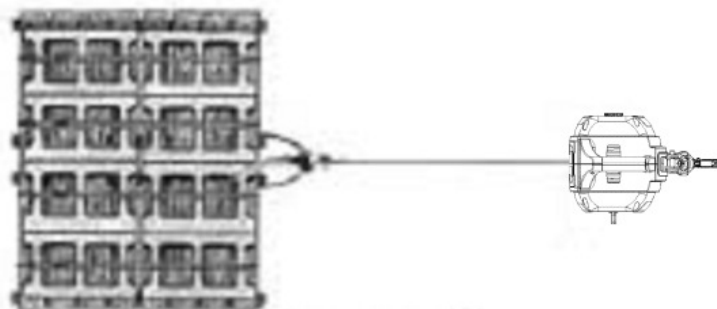

Single Line

⚠️ WARNING Always use supplied hook strap whenever spooling winch rope in or out, during installation or operation to avoid injury to hands and fingers.

⚠️ WARNING Always wear heavy gloves when handling winch rope.

Step 1: PUT ON GLOVES AND ATTACH HOOK STRAP.

(1) Put on gloves.

(2) Attach the supplied hook strap to the rope hook. **Note: Ensure the hook strap is attached to the hook on the winch rope, not the swiveling anchor hook.**

Step 2: CONNECT TO POWER SOURCE.

Note: If you are using a cordless drill, be sure your battery pack is fully charged before use. Follow your drill/driver manufacturer's recommendation.

(1) Using the chuck of your drill/driver, connect to the driver shaft on your winch.

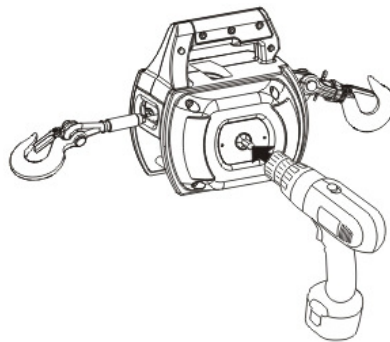

(2) Secure the chuck of your drill around the driver shaft tightly to avoid the drill slipping off the shaft.



⚠️ WARNING Always tighten drill to winch driver shaft. Drill can come loose and cause injury.

(3) If using a corded drill/driver, verify that power cords and extension cords are positioned so that the winch rope or moving load will not damage the cords or that cords can not be stepped on, tripped over, or otherwise subjected to damage or stress.

⚠️WARNING If using the driver bit accessory, make sure to insert bit straight into your drill's chuck jaws. Do not insert bit into chuck jaws off center. This could cause bit to be thrown from drill, resulting in possible personal injury or damage to the chuck.

Steps3: SPOOL OUT WINCH ROPE.

Freespooling is generally the quickest and easiest way to spool out winch rope.

⚠️WARNING Always keep hands clear of winch rope, hook loop, hook and fairlead opening during installation, operation, and when spooling in or out.

⚠️WARNING Always ensure the clutch is fully engaged or disengaged.

⚠️WARNING Never operate winch with less than 5 wraps of rope around the drum. Rope could come loose from the drum, as the rope attachment to the drum is not designed to hold a load.

(1) Pull out the knob and turn it clockwise to freewheel, the clutch is disengaged.

(2) While always keeping tension on the winch rope spool enough winch rope for the winching operation.

Spooling Alone: Attach the rope hook with hook strap to load and walk the winch away from load point.

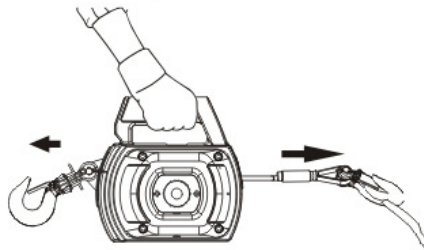

Spooling with an Assistant: Have the person handling the rope hold the hook strap and walk the winch rope away from the winch while spooling out the winch rope.

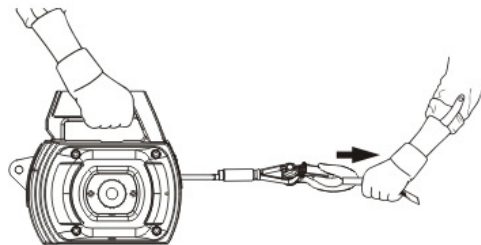

Step4: DETERMINE ANCHOR POINT AND SECURE.

⚠️WARNING Always be certain anchor will withstand load, use appropriate rigging and take time to rig correctly.

(1) Choose an anchor point that is sufficiently strong enough to withstand the maximum winching capacity of your winch.

NOTE: Choose an anchor point as far away as possible to provide the winch with its greatest winching power. A secure anchor is critical to winching operations. An anchor must be strong enough to hold while winching. Natural anchors include trees, stumps, and rocks. Remember to hook the winch rope as low as possible.

(2) Secure the winch anchor hook to the anchor point.

NOTE: You may combine any of our approved rigging accessories with the anchor hook for added stability.

⚠️ WARNING Never wrap winch rope back onto itself.
Use a choker chain or tree trunk protector on the anchor.



Step5:PLAN YOUR PULL

⚠️ WARNING Always avoid continuous side pulls which can pile up winch rope at one end of the drum.This can damage winch rope or winch.

(1) Line up your pull as straight as possible.This prevents side pulls that can allow the winch rope to rub on the fairlead.Side pulls cause the winch rope to stack up at one end of the drum.This can damage the winch rope or the winch.

Step6:SECURE TO THE LOAD.

(1) Establish a load point.Often a load does not have a secure load point.It may be necessary to secure the load with a choker chain or strap.

Step7:ATTACH THE CLEVIS/D-SHACKLE.

- (1) If using a strap,attach the shackle to the two ends of the strap being careful not to over tighten the shackle(tighten and back-off 1/2 turn)
- (2) Secure the shackle into the throat of the winch rope hook.

Step8:PUT WINCH ROPE UNDER TENSION.

- (1) Engage the clutch by pulling out the knob and turning is clockwise to get locked.
- (2) Press the rotation control switch on your drill/driver to the forward/clockwise position.
- (3) Use the trigger control to slowly wind the winch rope in until no slack remains.Tensioning in the winch rope will keep the winch rope from “ bird nesting” and binding.Make sure rope is winding from the top of the winch.
- (4) Once the winch rope is under tension,stand clear,and never step over the winch rope.

Step9:CHECK YOUR LOAD.

(1) Ensure all connections are secure and free of debris before continuing with winching.

Winching

The following steps describe how to operate the winch after it has been properly rigged.

Step10:LAY SOMETHING OVER THE WINCH ROPE

(1) In the interest of safety,consider hanging a dense fabric midway between the winch and the load point to absorb energy should the winch rope or load point snap loose.



Step11:MAKE YOUR INTENTIONS CLEAR.

⚠️ WARNING Always ensure the operator and bystanders are aware of the stability of the load.

- (1) Be sure that everyone in the immediate vicinity surrounding the winching operation is completely aware of your intention before you winch.
- (2) Declare where the spectators should not stand——never behind,in front of or under the load and never near the winch rope.

Establish “no people” zones



Step12:BEGIN WINCHING

- (1) With clutch in lock (engaged) position,press the rotation control switch on your drill/driver to forward/clockwise position.
- (2) With light tension already on the winch rope,begin pressing the trigger on your drill/driver and start slowly and steadily winching in.

NOTICE Avoid over heating the drill motor.For extended winching,stop at reasonable intervals to allow the drill motor to cool down.

What to look for under

As you winch in,make sure the rope winds evenly and tightly on the drum.This prevents the outer winch rope wraps from diving into the inner wraps, “bird nesting” and binding can damage the winch rope and winch.

During side pulls the winch rope tends to stack up at one end of the drum.To prevent stacking the winch rope on one side of the drum,line up the pull as straight ahead as possible.

Step13:SECURE LOAD.

- (1) Once movement of the load is complete, be sure to secure the load completely.

Step14:DISCONNECT FROM ANCHOR.

- (1) Once load is secure,release tension in the winch rope by reversing the rotation control switch (counterclockwise position) on your drill/driver and begin pressing the speed trigger on your drill/driver.
- (2) Slowly power out a short length of winch rope.
- (3) Disconnect anchor hook from the anchor.

Step15:POWER-IN WINCH ROPE.

- (1) With clutch still in the lock(engaged) position.
- (2) Press the rotation control switch on your drill/driver to forward/clockwise position.

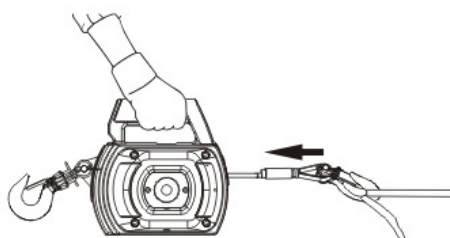

(3) Arrange the winch rope so it will not kink or tangle when powering-in by keeping tension on the winch rope.

NOTE: Be sure any winch rope already on the spooling drum is wound tightly.

(4) Slowly power-in the winch rope by pushing the speed trigger switch on the drill/driver and walk slowly towards the load until the rope hook is approximately 1 ft. From the fairlead.

!WARNING Never spool in rope hook against the fairlead; the rope hook should be loose at the fairlead.

(5) Once the rope hook is within 1 ft. From the fairlead, stop winching in and remove the rope hook from the load.

(6) Slowly pulse trigger to winch in the rest of the winch rope, leaving at least 6 inches from fairlead to rope hook.

(7) Winching operations are now complete.

(8) Remove drill/driver from winch by releasing/unlocking drill chuck from driver shaft.

(9) Store the winch in a clean and dry place.

FINAL ANALYSIS AND MAINTENANCE

CHECK	Before first operation	After each use	Every 90 days
Take time to fully read the instructions and/or Operations Manual, and/or Basic Direction to Winching Techniques, in order to understand your winch and its operations.	X		X
Read and understand your drill/driver operator's manual and instructions.	X		X
Inspect rope for damage. Replace rope immediately if damaged.	X	X	X
Keep winch, rope and switch control free from contaminants. Use a clean rag or towel to remove any dirt and debris.		X	

!WARNING To prevent serious injury or death:

Always spool the winch rope onto the drum as indicated by the drum rotation label.

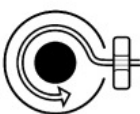

Always Wind Rope Over Top of Drum.



Never Wind Rope on Bottom of Drum.