



KIO-Winch

ELECTRIC MINI WINCH

With Wireless remote control

MODEL SRW-200 • SRW-250 • SRW-300



OWNER'S MANUAL

INSTALLTION
OPERATION
MAINTENANCE
SAFETY PRECAUTION
REPAIR PARTS



ISO 9001

Quality Management
QC011

▲ CAUTION ▲

READ AND UNDERSTAND THIS MANUAL
BEFORE INSTALLATION AND OPERATION
OF TOUR ELECTRIC WINCH PRODUCTS

7. SPECIFICATUON

MODEL		SRW-200	SRW-250	SRW-300
Lifting load top layer (kg)		200	250	300
Speed m/min		23	16	16
Motor	110V	1500W / 12.5A	1500W / 12.5A	1500W / 12.5A
	220/240V	1500W / 7A	1500W / 7A	1500W / 7A
Lifting Height (m)		29	29	29
Wire rope Φ mm x m		4.8 x 31	4.8 x 31	4.8 x 31
Gross Weight (kg)		15	15	15

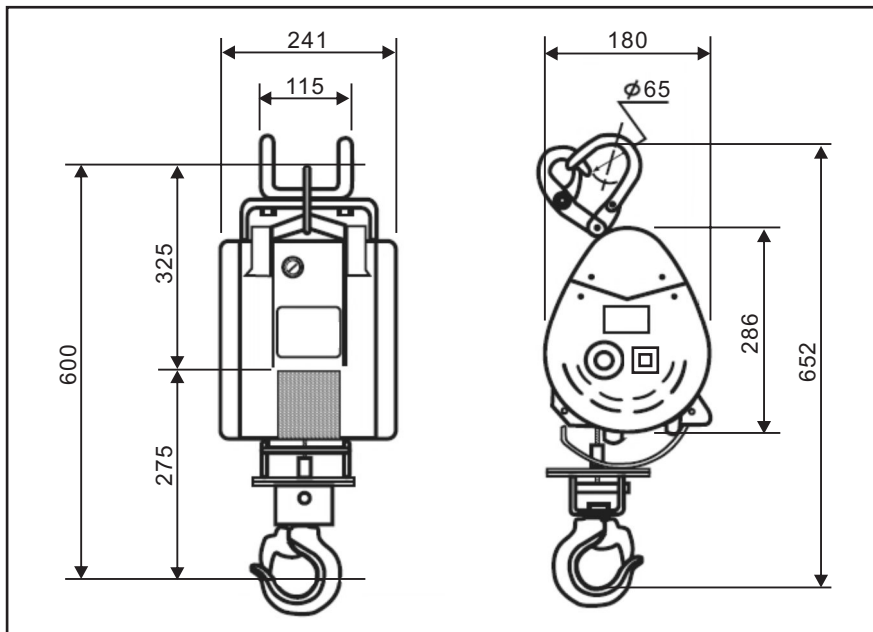

- Lightweight & compact design allow mounting convenient.
- When rope touches the limit arm, hoisting is automatically stopped.
- A sensor arm stops the motor when the rope is reverse winding.
- Dynamic brake designs for both static and dynamic loading.
- It operates on household power source.
- Plug-in cords allow portability with easy.
- 360° universal joint saddle hook with safety latch.

Mini winch with built-in safety

devices feature easy control of lifting for a wide range of applicability for warehouse, storage areas, factories, house areas, construction sites, job sites and plumbing.

2. INSTALLMENT PRECAUTION

2. 1 ENVIRONMENT PRECAUTION:

 WARNING	
	<ul style="list-style-type: none"> • The following environmental conditions may result in the possible causes of winch trouble.

- Low temperature below -10°C high temperature above 40°C or humidity above 90% conditions.



- In an organic chemistry or explosive power conditions



※Cause explosion

- In heavy acid or salty conditions

※Cause malfunction of spare part

- In the rain or snow

※Cause rust or short circuit





- In a heavy general powder conditions

※Cause malfunction of performances



2. 2 CONTINUOUS RATING:

 PRECAUTION	
	<ul style="list-style-type: none"> • Never hoist over the rated percentage duty cycle

The service life of the winch is depending on the conditions of the load and working frequency.

In the long time operation, make sure to use the machine within its continuous ratings.

Continuous rating means the working duty cycle (%ED) is subject to the rated voltage rated frequency and a 63% of rated load.

All mini winches are rated 25% percentage duty cycle (%ED)

$$\text{Percentage duty cycle (\%ED)} = \frac{T_b}{T_b + T_s} \times 100(\%)$$

T_b: total sum of overall loading operating hours

T_s: total sum of stopping hours

T_b+T_s = approximately 1 to 10 min

The maximum of starts of the machine means the number of starts of motor per 1 working hour including the pause hours of winch which is value of number working times added with the number of inching.

2. 3 MOUNTING:

The winch designed to be hanged or mounted on a firm or stable bar or a bracket.
When hanging, do not allow the body or load to be caught by any construction of frame, or other obstruction.

Be sure to lock the hanger for extra safety.

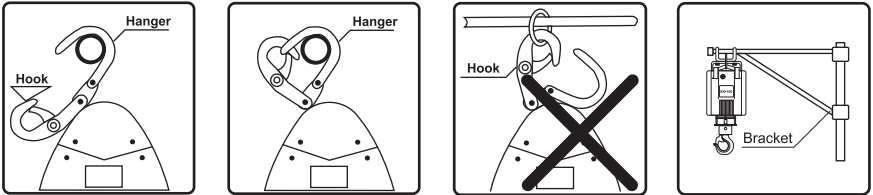

2. 4 PLUG INSERTION:

2. 4 (a) Power core insertion:

Insert the power plug into the power receptacle of the winch, and tighten it by turning the locking ring, clockwise.

Be sure to lock the cord by a holder, Do not allow the cords to be caught by wire rope and drum.

The length of power cord is subject to the distance of 20 meter, for any other case, please use a power cable by 3.5mm² to prevent a considerable voltage drop to be happened.

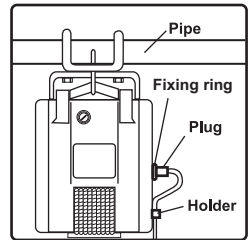

Suggest extension power cord diameter

Diameter	Cord Length
2.0mm ²	20m
3.5mm ²	35m

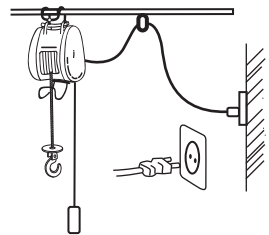

2. 4 (b) Grounding:

To prevent the risk of electric shock, the power plug must be plugged into a matching outlet and grounded in good condition.

3. WORKING METHODS

3. 1 PREPARATION BEFORE WORKING:

- Be sure to carefully check all safety and environmental conditions.
- A minimum of five (5) wraps of wire rope wound around the drum is necessary.
A wire rope should be discarded and not be used again if rope shows sign of excessive wear too many broken wires. Corrosion or other defects.
- Make sure to connect the main power source and grounding.
- It's not safe to lift loads exceeding the rated load.
- Connect power source at rated voltage.
(It will cause maladjusted working if input voltage falls out of rated voltage by $\pm 10\%$)

3. 2 UP AND DOWN SWITCHING:

To lift a load, press \uparrow button and drum will rotate as shown below operation.
To lower a load, press \downarrow button and drum will rotate as shown below.

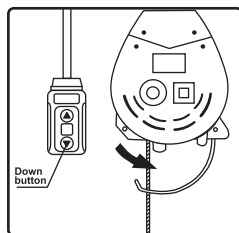
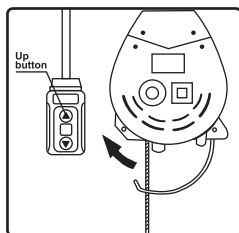

When the button is released, the drum will stop moving

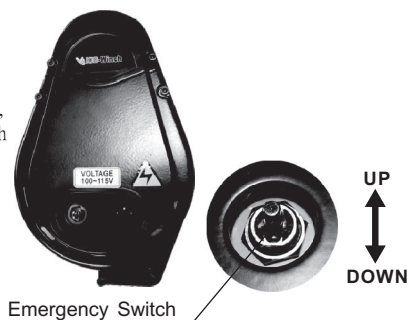

3. 3 Emergency Switch

- If your wireless remote control is malfunction or lost in the loading situation. To avoid the danger, please operate the emergency button on the winch body to move the loading things to safe place.
- When you turn the lever up, the hook will rise.
Turn the lever down, the hook will descend.



4. HANDING PRECAUTION

4. 1 ENVIRONMENT PRECAUTION:

 WARNING	
	<ul style="list-style-type: none">• Pay best attention to the following instruction. Obvious mistakes in operation may result in personal injury or equipment damage.• The winch cannot be used as an elevator or for personnel going up or down.

- Never try to lift a load more than the rated weight.



- Never hitch a ride on the hook, sling or load being moving.



- ※ Winches are not to be used for lifting or lowering people.

- Don't work, walk or stand under an operating winch.



- Always remain in control. Never neglect the winch while actually hoisting a load.



- While working, never stand under a lifting load or within the conveying area.

- Always watch out when working around winch, there is potential danger overhead.



- Never gravitate a load freely.



- ※ Be sure to lift a load vertically. Slack may allow wires to be caught in the drum.

- A minimum of five (5) wraps of rope around the drum is necessary to support the load rated.

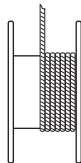

- Prior to starting of use, carry out the daily checking without fall, and after confirming the safety of function.



- If having a counter rotation incurred, make sure to correct its turning direction.
- Before lifting. Make sure to have a precise performance of brake. If any malfunction of brake happened, stop the operation immediately.

- When load suspended in the air, it will not allow to be welding. Never weld a load while actually lifting a load.



- Wire rope with one or more of the following defects shall be removed or replaced immediately.
 - (1)kink
 - (2)distortion
 - (3)corrosion
 - (4)showing sings of excessive wear or of having broken wires not less than 10 pcs.

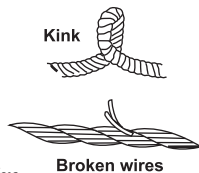

- Stop the operation if there is any queer noise or vibration in the gear box.
- Do not connect the wire rope with the grounding of welding machine.
- While welding, do not have any contact with the welding objects because of having spark.

- Do not pull the switch cord to move a load.
- Do not over continuous ratings.



- Never plugging (instant reverse-wind) and inching.



- In order to prevent the layer down due to over loosening of rope, irregular winding, etc.,operate according to the suitable operating method.
- Use a winch by fixing so securely that the rope around the drum is uneven.
- Be sure to fix a rope in the center of swivel hook.
- Be sure to stop operation immediately when the wire rope become fully slackened.
- Avoid catching the hook or lifting a load on a fixed obstruction.
- Always leave the push button switch positioned immediately after use.
- Make sure that the load being lifting are well balanced and secured before starting.
- Avoid water splashes on the push button switch.
- Never wrap the load with the wire rope.

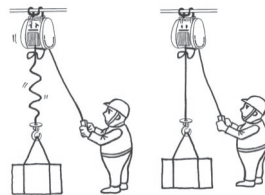
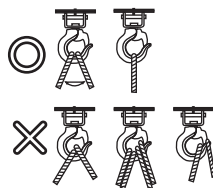

5. 1 OIL LUBRICATION:

Winch are prefabricated at the factory and do not require initial lubrication. Relubrication interval depends upon service. Recommended oil replenishment quantity & intervals are as follows.

Grease Grade	Quantity			
	SRW-200	SRW-250	SRW-300	Intervals
NLGI NO.0				
Caltex Multifak Ep	250cc	250cc	250cc	1 Year
Cosmogear SE220				

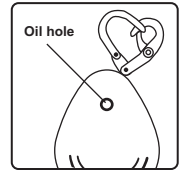

5. 2 CARBON BRUSH REPLACEMENT :

WARNING



- Clean the accumulated powder of carbon brush periodically to ascertain the insulation resistance up to 1Ω .

- It is essential to check the carbon brush periodically. The length is left less than 7.5mm resulting from wearing, it is absolute necessary to replace carbon brush immediately.
- While replacing, smoothly insert carbon brush into carbon brush holder in the first place. And then put brush cap into the hole.
- Before tightening the carbon brush holder, make sure to position 0 ring.
- A set of carbon brush consists 2 piece of carbon brush. Ascertain to replace 2 pcs of carbon brush on opposite sides of winch body at the same time.

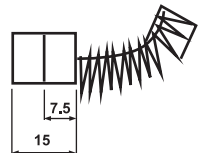
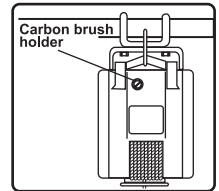

Carbon brush length

5. 3 BRAKING :

- Braking device are composed of a mechanic brake and a electronic generated brake. The brake distance from the time of braking until stopping completely should be within 1.5% of rope length to the wound in during 1 minute.
- Owing to the rope speed on no load is faster than that on rated load, the brake distance on no load will be longer, but still within 1.5% of rope length.
- The rope speed on no load is 1.5-1.8 times of rated speed on rated load.

5. 4 OVER-WINDING LIFT PREVENTION DEVICE:

- A special mechanism prevents a over-winding when lifting.
- When the swivel hook touches the limit lever. Lifting is automatically stopped.
- However, if the limit lever distance is set too close to the winch body, it will cause serious damage to the limit lever and the winch body.
- As below is the suggested distance between the limit lever and winch body.

MODEL	SRW-200	SRW-250	SRW-300
DISTANCE	70-90mm	70-90mm	70-90mm

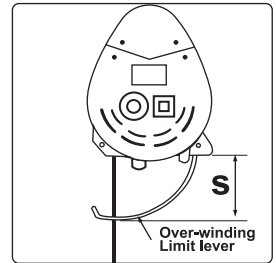

5. 5 REVERSE WINDING PREVENTION DEVICE:

- A special mechanic prevents a over reverse-winding when lowering.
- When lowering a wire rope is fully extended, the wire rope will be shifted its position from O to X.
- When a wire rope touches the limit lever of over-winding prevention device. Lowering will be automatically stopped.
- When the wire rope is shifted to the position of X. Pull it and press the ↑ button to return its position to O.

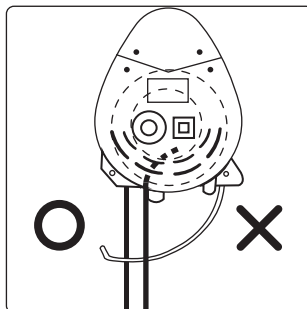

SRW-200/250/300

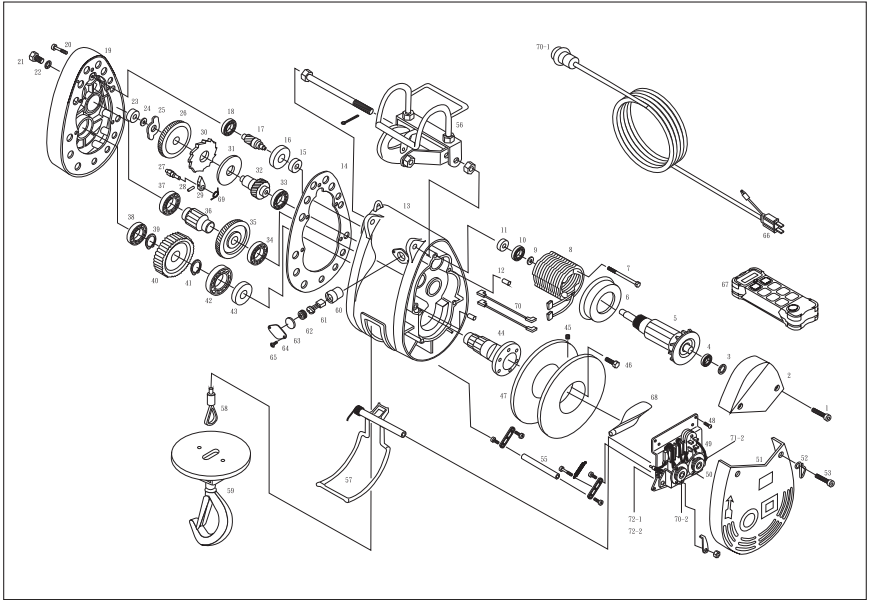

NO.	DESCRIPTION	Q'TY	NO.	DESCRIPTION	Q'TY	NO.	DESCRIPTION	Q'TY
1	HEX BOLT	3	24	BUST	1	47	DRUM	1
2	MOTORCOVER	1	25	1/2CIRCLE-KEY	1	48	SCREW	4
3	WASHER	1	26	2ND GEAR	1	49	CONTROL ASS'Y	1
4	BEARING	1	27	SET BOLT	1	50	PLASTIC PACKING	1
5	ROTOR+1ST PIONIN	1	28	SPRING	1	51	ELECTRIC COVER	1
6	FAN COVER	1	29	PAWL	1	52	RING	1
7	HEX-BOLT	2	30	RATCHET	1	53	HEX BOLT	4
8	FIELD COIL ASSY	1	31	BRAKE-DISK	1	55	DOWN LIMIT ARM ASSY	1
9	C RING	1	32	3RD SHAFT	1	56	SUPSPENSION HOOK ASSY	1
10	BEARING	1	33	BEARING	1	57	UP LIMIT ARM ASSY	1
11	OIL RING	1	34	BEARING	1	58	WIRE ROPE ASSY	1
12	KNOB PIN	2	35	3RD GEAR	1	59	SWIVEL HOOK	2
13	GEAR CASE	1	36	4TH SHAFT	1	60	CARBON HOLDER	2
14	PACKING	1	37	BEARING	1	61	CARBON BRUSH	2
15	BEARING	1	38	BEARING	1	62	BRUSH CAP	2
16	1ST GEAR	1	39	C RING	1	63	O RING	2
17	2ND SHAFT	1	40	4TH GEAR	1	64	BRUSH COVER	2
18	BEARING	1	41	C RING	1	65	SCREW	4
19	GEAR CASE COVER	1	42	BEARING	1	66	POWER CORD ASSY	1
20	HEX BOLT	7	43	OIL RING	1	67	WIRELESS REMOTE	1
21	HEX BOLT	1	44	OUTPUTSHAFT	1	68	ROPE STOPPER	1
22	O RING	1	45	P.T.SCREW	1			
23	BEARING	1	46	HEX BOLT	6			